

FALCON ANCHORS™

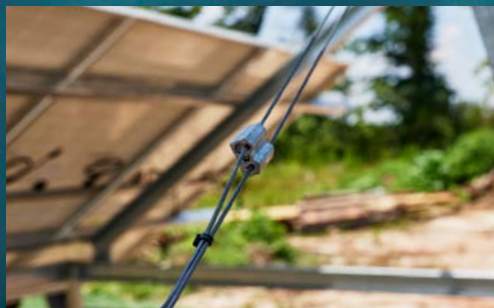

FALCON ANCHOR SYSTEMS OVERVIEW



ANCHORED SOLUTIONS FOR ALL APPLICATIONS

The Falcon line of anchoring products are designed to be a *True Force of Nature*. Designed to grip, drive, and protect in a wide range of securing applications, Falcon Anchor Systems can provide unique solutions for a wide range of applications.

The versatility of the Falcon Anchor System products allow for their use across different industries with USA made percussion driven anchors, wire pins, and wire tensioners. Customize or combine components into a wide array of solutions. Learn more about the full line at www.falcon-anchors.com



CIVIL

From steep slopes to channels, to utilities services and hard armor securing, the Falcon Anchor, Pins, and Tensioners can be used on active construction site projects.

SOLAR

Whether stabilizing solar structures at the ground level, providing flexible bracing, or protecting from drip zone water erosion, Falcon Anchor Systems can find solutions.

RECREATIONAL

Camping, hunting, backyard activities or a day at the park, Falcon Anchor Systems can be used for permanent to temporary tie-down stabilization, shade tensioning, or even safety and security solutions.

AGRICULTURAL

You can find a use for our Falcon Anchor Systems in tree nurseries, vineyards, livestock fencing needs and more. Our wire tensioning and tie-down solutions offer options for many agricultural projects.

FALCON ANCHOR SYSTEMS A 'FORCE OF NATURE'

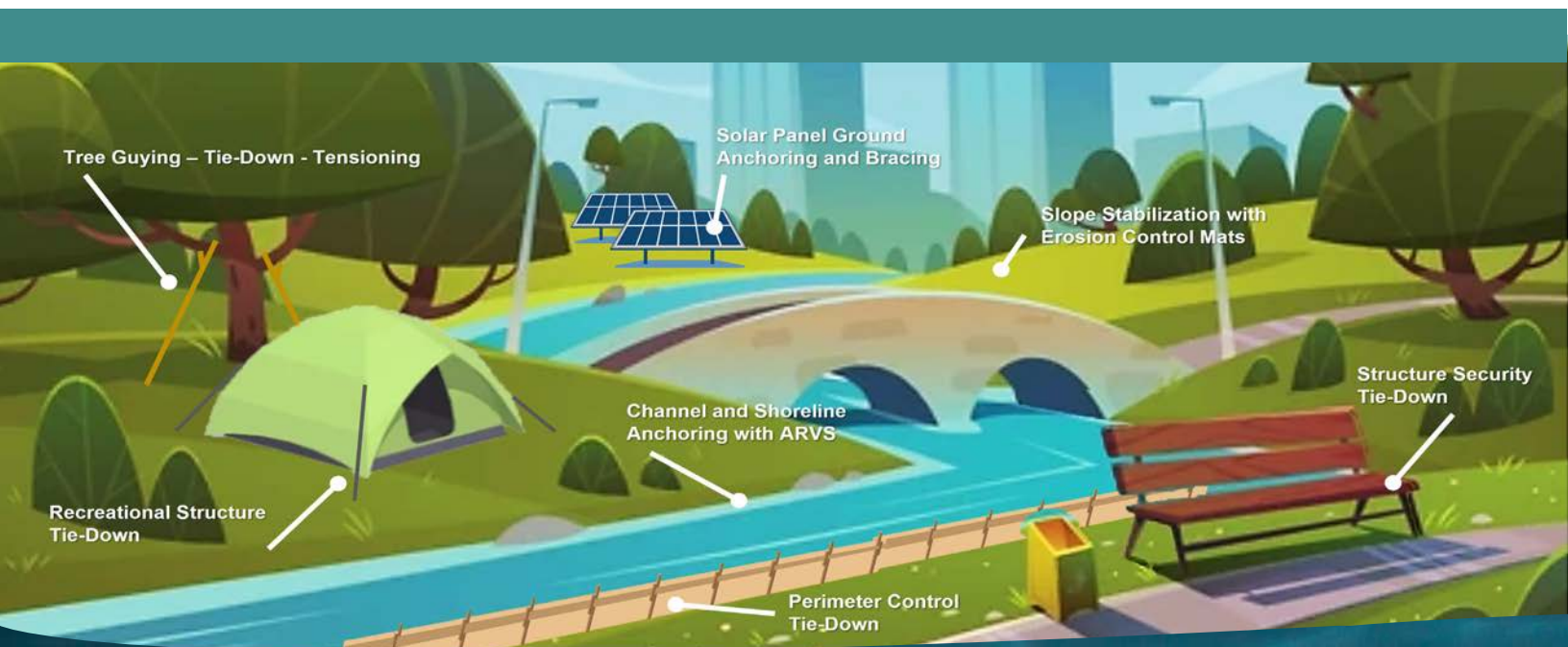

FALCON ANCHORS™

The Falcon Anchor line provides securing hardware for ground anchoring across applications like civil and solar construction application. Falcon Anchors provide innovative, cost-effective solutions and are designed to provide immediate stabilization, requires no crimping and have improved load-locking capabilities, for easy installation. The Falcon Anchors are pre-assembled and are available in different configurations to best meet the specified project requirements and geotechnical conditions. Installing Falcon Anchors offers the performance needed while ensuring considerable time and labor savings.



FALCON PINS™

The Falcon Hex Pins are an innovative fastener providing significantly greater pullout resistance than typical straight pins or staples. Available in configurations specialized for different soil types, the Falcon Hex Pins improve pullout performance in soft or sandy soils, compact, cohesive soils, and even hard, rocky soils. This allows for better tie down of erosion control materials, guy wires, strapping and more in a wide range of industry applications. The Falcon Hex Pins are installed using a hand drill with either a custom chuck or a standard 1.5" hex socket. Installing the fasteners is quick and easy. Galvanized for long life, and more durable than hand driven fasteners, Falcon Hex Pins are more reliable and provide greater confidence in tie-down applications.



FALCON LOCK GRIP™

The Falcon Lock Grip LG-3 is designed to provide a two-way grip of wire rope for a variety of bracing applications including solar applications, nursery applications, fabric tensioning, and more. The LG-3 can be used to couple wire ropes or form a loop with little loss of load capacity. In addition to high load capacity, the LG-3 utilizes patent pending Dynamic Vibration Arrest (DVA) technology. This ensures the entire device vibrates in unison with the wire. Without DVA, in the case of wind or other vibration, a wire grip can shake loose, allowing the tie to fail. DVA prevents vibration failure. LG-3 grips provide the highest level of safety with the easiest installation and widest application portfolio of any gripping device.



FALCON ANCHORS™

Solutions for All Industry Applications

CIVIL

SLOPE STABILIZATION

The Falcon Percussion Driven Anchors (PDAs) are deep-seated anchors that are embedded in the soil under a potential failure plane, harnessing the strength of a surface applied fabric to hold saturated, surficial soil. Custom configurations of PDAs can help provide the appropriate ground protection on adverse slope conditions.

CHANNEL & SHORELINE STABILIZATION

In high concentrated flow applications, the Falcon Anchors can be used in conjunction with surface stabilizing fabrics and grids to increase the loading and survivability of the application. The addition of Falcon Anchors provide a high performance, reliable and cost-effective means to increase overall safety factor of a project.

HARD ARMOR ANCHORING

In high concentrated flow applications, the Falcon Anchors can be used in conjunction with hard armor solutions such as gabion mattresses, articulated concrete block mats, transition mats, and more.

BUOYANCY TIE-DOWN

When installing underground utility services, Falcon Anchors can be used in conjunction with straps to prevent buoyant movement during installation. The strong grip of the Falcon Anchors allows concrete setting of pipes and conduit without upward movement.

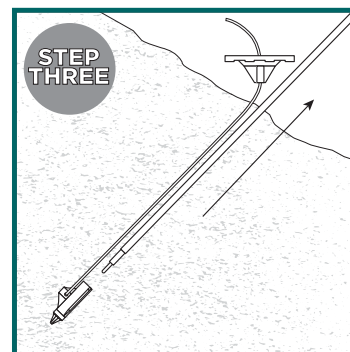
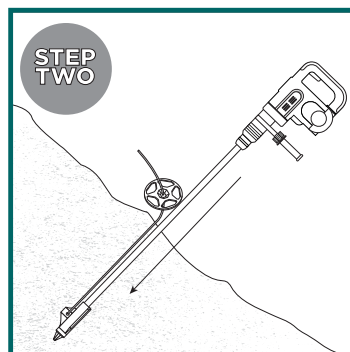
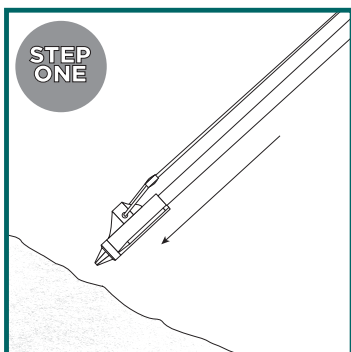

Step 1: Insert the drive rod into the Falcon anchor head and place perpendicular to the slope. Insert drive rod with anchor head swiftly through the mat in the desired location.

Step 2: Drive the Falcon Anchor to the desired depth. Anchors can be driven using a sledge hammer, gas powered driver, or hammer drill.

Step 3: Remove drive rod. In soft soils, the drive rod can be removed by hand, in tougher soils the use of a JackJaw™ may be required.

SOLAR

SOLAR FIELD GROUND PROTECTION

The Falcon Anchors allow for easy ground mount installation on solar racking system applications on any terrain without pile driven foundations or concrete pads. Falcon Anchors can provide ground protection from erosion along drip edges, linear waterways, slopes and more.



RECREATIONAL

SECURITY TIE-DOWN

Whether in a park, a school, or another public place, the Falcon Anchors can be used to safely secure equipment such as park benches, picnic tables, trash cans and more into the ground to reduce the lose of equipment to theft and vandalize.



AGRICULTURAL

TREE GUYING & ROOT BALL STABILIZATION

For large trees and shrubs and bare-root plants, the Falcon Anchors can be used with guy wire and LockGrip tensioners to safely anchor and stabilize new landscape installations.



END POST & FENCE BRACING

Add stability and security to your fencing posts and gates with ground anchors. Create tie off points without needing to add deep-seated concrete or steel footings.

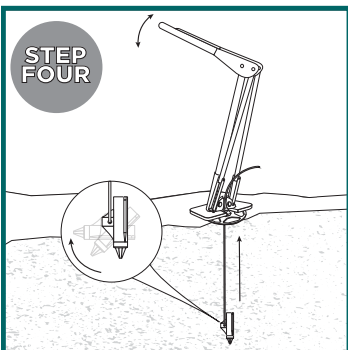

Step 4: Load-lock the anchor once the rod is removed. Slide the termination cap flush to the ground. With handle in the up and open position, place JackJaw baseplate directly over the termination cap. Ensure the cable is in line with the JackJaw jaws, move the lever handle in a full down/up motion. Pump until resistance is felt and top cap is slightly recessed in the mat.

Step 5: For anchors utilizing the S or SW termination caps, manual locking of the faceplate ensures proper anchor setting even in soil conditions where fully countersinking the termination cap cannot be achieved. Using a 1/8" diameter tool with a minimum 1" depth, fully engage the locking mechanism of the top termination with a firm tap into the setting hole. Test the lock by pulling upward on the termination cap.

Installation Tools: Installing Falcon Anchors requires the use of a few key installation tools for ease and success, including drive rods in varying lengths and diameters. Consider a gas-powered driver, and a JackJaw™ tool for easy driving and setting.

FALCON ANCHORS™

Advancing Anchoring with Falcon Anchors

Falcon Anchors take the best of existing anchor system technology and builds improved anchoring products that are a true **FORCE of NATURE**. Falcon Anchors feature improved quality, performance, and system installation, resulting in advanced anchored products that perform to the highest tested technologies.

Falcon Anchors grip and dig into the soil for a streamlined installation and performance with a high factor of safety.

Casted and assembled in the USA, and with quicker load-locking capabilities, Falcon Anchors can be in-place controlling against nature's forces from day one. When combined with other ground control products like High-Performance Turf Reinforcement Mats, transition mats, or articulated concrete block mats, the result is a completely integrated armoring system that can be curated to your specific design parameters. Or if you need help securing a structure, the Falcon Anchors can provide the performance needed.

Start specifying with our complete line of anchors, to reach your erosion and slope stabilization goals.



The Falcon Anchors are available in custom configurations which can be designed to optimize performance and value to site-specific challenges. The F80-X-Z anchor pictured above is ideal as a light-weight workhorse assembly.

Falcon Anchor Series (Typical assemblies. Additional assembly variations available)

Assembly/Part	F80-X-Z Series	F120-X-Z Series	FL120-SW-Z Series	FL170-SW-Z Series
Cap	4" Dia. Zinc Alloy	4" Dia. Zinc Alloy	6" Dia. Zinc Alloy	6" Dia. Zinc Alloy
Grip	Spring-Loaded Ceramic Crush Roller	Spring-Loaded Ceramic Crush Roller	Spring-Loaded Ceramic Crush Roller	Spring-Loaded Ceramic Crush Roller
Cable	1/8" Dia. ZA Coated Steel, 3 ft Typ.	1/8" Dia. ZA Coated Steel, 6 ft Typ.	1/4" Dia. ZA Coated Steel, 6 ft Typ.	1/4" Dia. ZA Coated Steel, 6 ft Typ.
Anchor	Zinc Alloy 3.1" (80mm) x 1.30" (33mm)	Zinc Alloy 4.7" (120mm) x 1.57" (40mm)	Zinc Alloy 4.7" (120mm) x 1.57" (40mm)	Zinc Alloy 6.7" (170mm) x 2.17" (40mm)
Anchor Bearing Area	3.4 in ² (22.0 cm ²)	6.0 in ² (38.7 cm ²)	6.0 in ² (38.7 cm ²)	12.2 in ² (79.0 cm ²)
Typ. Working Load	750 lbs	750 lbs	2,500 lbs	3,000 lbs
Max. Working Load	1,300 lbs	1,300 lbs	2,700 lbs	3,500 lbs
Ultimate Assembly Strength	1,500 lbs	1,500 lbs	3,000 lbs	3,800 lbs
Ultimate Cable Strength	2,100 lbs	2,100 lbs	7,000 lbs	7,000 lbs
Typical Use	Workhorse Light Assembly	Soft Soil Workhorse Light Assembly	Hard Soil Heavy Assembly	Standard/Soft Soil Heavy Assembly

Falcon Anchor Head Dimensions

F80

3.1" (80 mm)



F120

4.7" (120 mm)



F170

6.7" (170 mm)



Falcon Cap Options



X Cap

4" Dia. Zinc Alloy



S Cap Insert

2" Dia. Zinc Alloy



SW Cap

6" Dia. Zinc Alloy

Installation Features of the Falcon Anchors

- Flush back-end allows anchors to be driven with no internal force, resulting in less breakage and easier driving
- Anchors are configured to allow multiple driving options to meet installation needs.
- Casted and manufactured in the USA, can be used on ARRA projects.
- Strengthened and centered anchor bridge result in quicker load-locking and less breakage at cable joint.

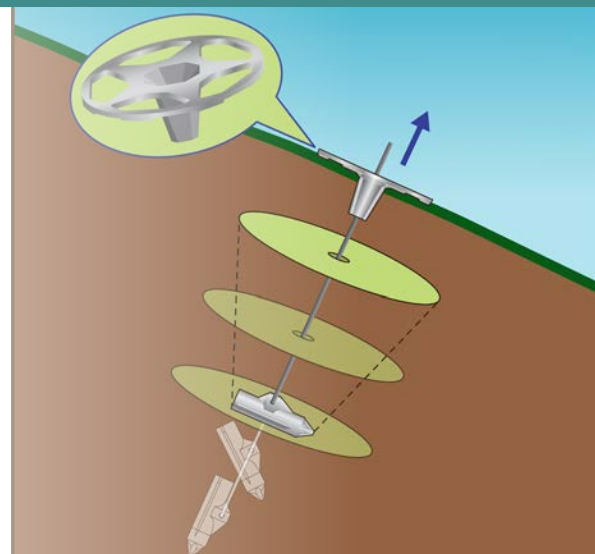

FALCON PINS™

Solutions for All Industry Applications

CIVIL

EROSION CONTROL BLANKET FASTENING

The Falcon Hex Pins are an innovative fastener providing significantly greater pullout resistance than typical straight pins or staples. Galvanized for long life, and more durable than hand driven fasteners, Falcon Hex pins are more reliable and provide greater securing of erosion control blanket and turf reinforcement mat tie down.



SEDIMENT CONTROL SECURING

When using sediment control logs for perimeter control, shoreline protection, or slope stability, the Falcon Hex Pins can be used with rope or tape to lash the sediment control devices in place. This install can remove the need for elevated wood stakes.



RECREATIONAL

TIE-DOWN SOLUTIONS

With three different coil configurations specialized for different soil types, the Falcon Hex Pins improve pullout performance in soft to hard soils. The Falcon Hex Pins can be used with guy rope to secure temporary structures such as recreational equipment, play equipment, tents, deer blinds, and more.



Falcon Hex Pins can be used to stabilize recreational equipment like yard inflatables, trampolines, hunting blinds, and other structures that require a temporary or semi-permanent tie-down solutions that can easily be removed and reused. Falcon Hex Pins can be used with ropes, straps, landscape tape and more.

AGRICULTURAL

STAKING SOLUTIONS

With three different coil configurations specialized for different soil types, the Falcon Hex Pins improve pullout performance in soft to hard soils. The Falcon Hex Pins can be used with guy rope to secure temporary structures such as recreational equipment, play equipment, tents, deer blinds, and more. When coupled with tree strap or tape, the Hex pins can be used to provide tree and other landscape staking.

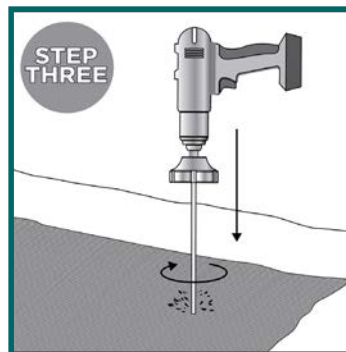
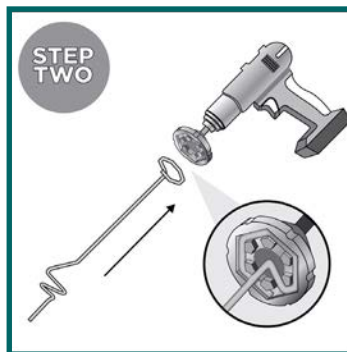
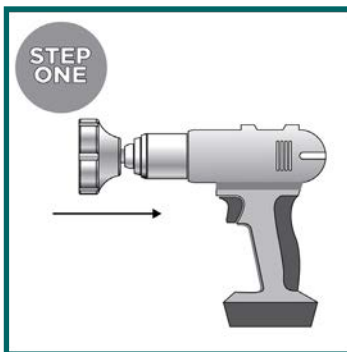
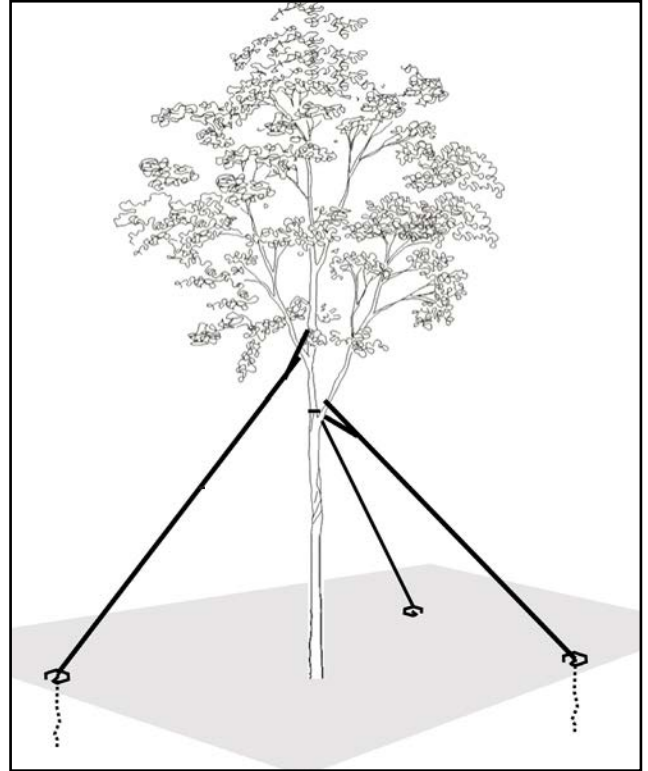

Step 1: Insert the custom chuck or a standard 1.5 inch hex socket into a hand drill.

Step 2: Place the Falcon Hex Pin into the hex socket. Ensure no debris is on the twist pin before installing.

Step 3: Place the end of the Falcon Hex Pin through the erosion control matting, landscape tape, or other fabrics before engaging the drill. Install the pin with slight pressure until the pin is fully installed.

Step 4: A properly installed Hex pin will impart a slight depression on the ground surface. If using lightweight netted matting, edge installation may need to be held as not to twist the matting.

Note: Guy ropes can be tied to the Falcon Hex pin either before installation or after driving the pin based on accessibility.



Advancing Tie-Down Capabilities with Falcon Hex Pins

The Falcon Hex Pins are an innovative fastener providing significantly greater pullout resistance than typical straight pins or staples. Available in configurations specialized for different soil types, the Falcon Hex Pins improve pullout performance in soft or sandy soils, compact, cohesive soils and even hard, rocky soils. These specialized pin configurations allows for better tie down of ground fabric seams, light-weight structures, securing trees, and more. Their simple construction can be a replacement of more costly hardware in some instances.

Falcon Hex Pins are designed with a large diameter head which gives ample catch on mats, blankets, fabrics, and tree strap or tape without the need for additional washers. Falcon Hex Pins are more reliable and provide greater confidence ground securing tie down.

Start specifying with our complete line of hex twisted pins, to reach your ground anchor stabilization goals.

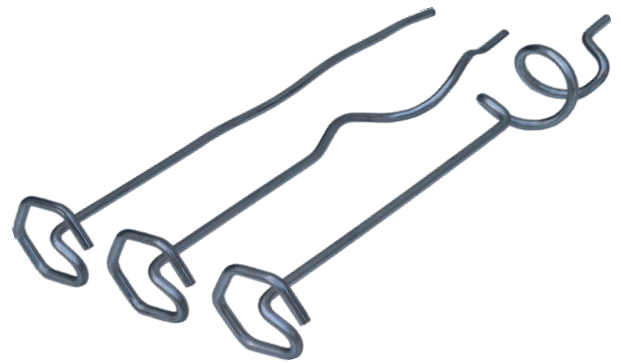

The unique hexagonal head of the Falcon Pins allow for easy installation with a hand drill. The unique coil shapes are designed for optimum pull-out strength in varying soil types. Shown Left to Right: HR-8, HC-8, and HS-8.

Falcon Hex Pins Designed for Performance

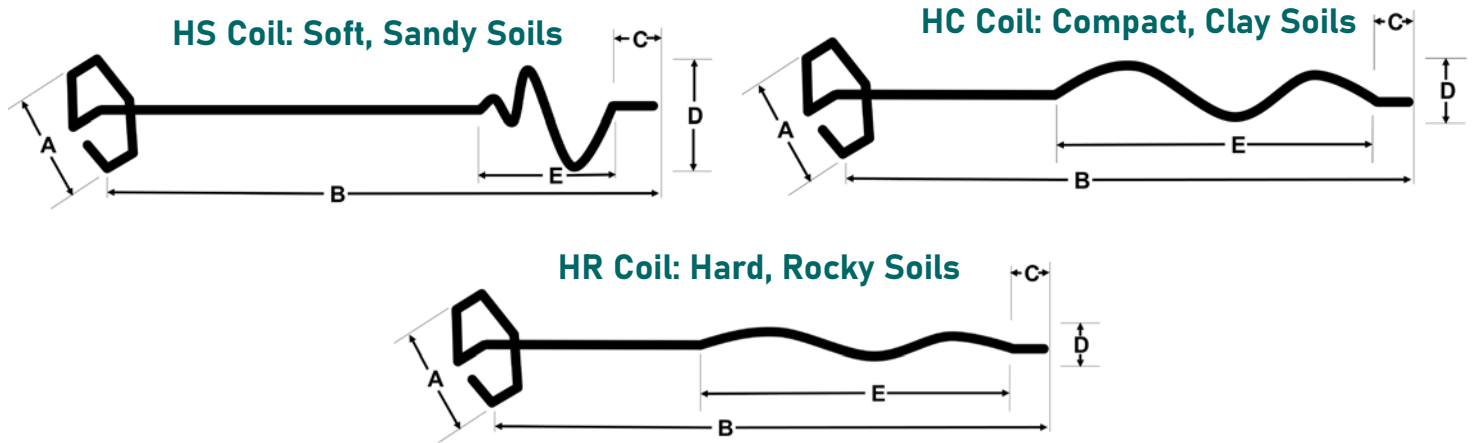

Dimensions		HS-8	HS-12	HC-8	HC-12	HR-8	HR-12
Hex Diameter (A)	in (cm)	1.5 (3.8)	1.5 (3.8)	1.5 (3.8)	1.5 (3.8)	1.5 (3.8)	1.5 (3.8)
Pin Length (B)	in (cm)	8.0 (20)	12.0 (30)	8.0 (20)	12.0 (30)	8.0 (20)	12.0 (30)
Tail Length(C)	in (cm)	0.5 (1.3)	0.5 (1.3)	0.5 (1.3)	0.5 (1.3)	0.5 (1.3)	0.5 (1.3)
Coil Diameter (D)	in (cm)	1.3 (3.2)	1.3 (3.2)	1.0 (2.6)	1.0 (2.6)	0.3 (0.7)	0.3 (0.7)
Coil Length (E)	in (cm)	2.5 (6.4)	2.5 (6.4)	3.0 (7.6)	3.0 (7.6)	3.0 (7.6)	3.0 (7.6)

Soil-Specific Pullout Resistance Performance

In comparison to other fasteners, Falcon Hex Pins provide up to ten times the pullout resistance of other fasteners. Typically, a minimum of 25-50 pounds of pullout resistance is required for ground fabrics sustaining water flow. In soft soils, staples or straight pins may only provide 10-15. Falcon Hex Pins make these projects viable with greater than sufficient pullout in poor soils.

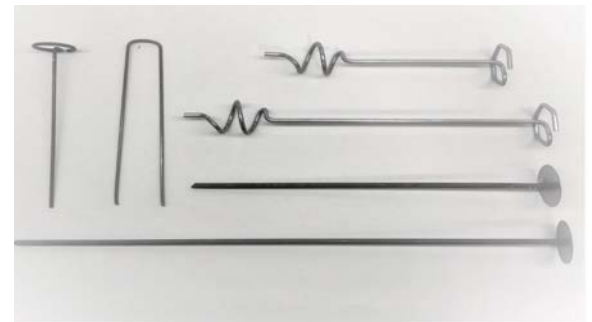
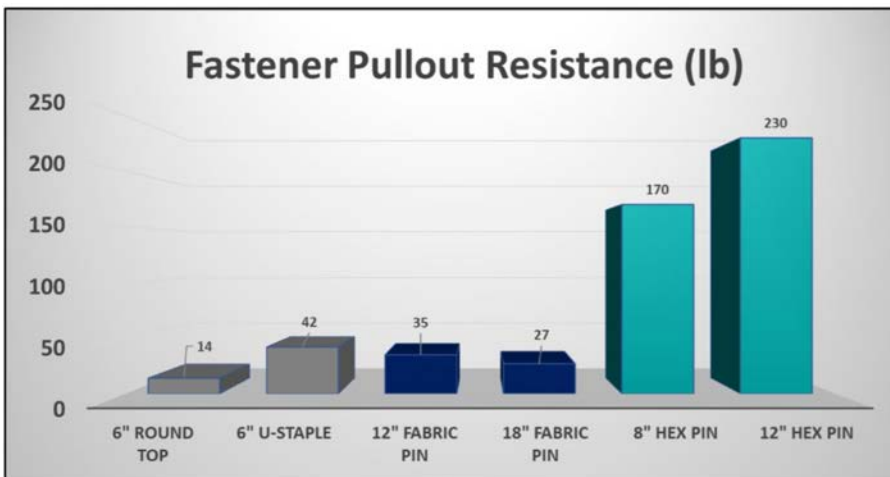

Falcon Hex pins show superior strength compared to other standard fasteners. Pullout resistance will vary based on soil type. A pullout test should be conducted to verify strength. A minimum 20 lbs pullout resistance is recommended for use with rolled erosion control products.

Installation Features of the Falcon Hex Pins

- Galvanized for longer life, and more durable than wire fasteners
- Falcon Hex Pins are installed using a hand drill with either a custom Falcon hex chuck (far right) or a standard 1.5" Hex socket (right).
- Manufactured in the USA, can be used on ARRA projects.



FALCON LOCKGRIP™

Solutions for All Industry Applications

SOLAR

SOLAR BRACING & TENSIONING APPLICATIONS

The Falcon LockGrip tensioner allow for the utilization of flexible bracing over traditional rigid systems. The two-way grip of the LockGrip's patent-pending Dynamic Vibration Arrest (DVA) technology provide a safe method to install solar racks with lightweight, high-strength bracing while retaining structural integrity. Our LockGrip tensioners are used with 1/8" wire, and we can also provide cable brace wires to specification as well.



Falcon LockGrip tensioners can be used to tension cable braces on solar rack installation. Whether in a cross or whiplash configuration, the LG-3 can increase the total working load.

RECREATIONAL

WIRE TENSIONING APPLICATIONS

The Falcon LockGrip tensioners can be used in many wire tensioning applications as they are easily adjustable and easy to install with its two-way wire rope grip. Falcon LockGrips can be used to create wire rope loops, couple wire ropes together, and other uses in high-load applications. Sun Shade, sails, and other tensioned fabric designs may benefit from the use of the Falcon LockGrip.



For sun shades, sails and other wire tensioned products, the Falcon LockGrip LG-3 can be used to create a secure system safe from high-wind vibrations.

AGRICULTURAL

TRELLISING & FENCING SOLUTIONS

The Falcon LockGrip tensioners and cable can be used across a wide variety of trellis and wire fencing applications. They can be used to join and tension wire for use in crop production, barbed, and plain fence enclosures for a strong and simplified installation.

TREE GUYING & ROOT BALL STABILIZATION

For large trees and shrubs and bare-root plants, the Falcon LockGrip tensioners can be used with guy wire and Falcon Anchors to safely anchor and stabilize new landscape installations.



Use the Falcon LockGrip LG-3 to create solutions for wire trellising or barb wire splicing for agricultural or landscape use.

Installation Made Easy with Falcon LockGrip™

The Falcon LockGrip LG-3 tensioner can be used in a variety of configurations for different applications. The two, one-way grips are designed to allow adjustable grip locking by activating and setting the dynamic vibration arrest (DVA) feature. The grip can be used to couple cables together or form a loop, allowing the cable to be passed through/around a last point to fix structures/assemblies. Once the cable(s) have been passed through the grip, the DVA is engaged by twisting the set screw. Once completed, the wire is clamped to the case of the grip, keeping the grip from vibrating independent of the cable in windy conditions.

In the event additional tension is required, or other adjustments are necessary, the set screw can be loosened and the wire released by engaging the grip release function. This saves time in money in having to clip wire and set a new tensioner should you opt to adjust the setting

Follow the QR code to see the Falcon LockGrip LG-3 in action on a solar rack bracing application, and see our full LG-3 installation Guide for step-by-step instructions on setting, tensioning, and adjusting the LG-3 tensioner.



SCAN QR CODE
For Full Installation Video



FALCON LOCKGRIP™

Cable Bracing and Tensioning

The Falcon LockGrip LG-3 is designed to provide a two-way grip of wire rope for a variety of bracing applications including solar applications, nursery applications, and more. The LG-3 can be used to couple wire ropes or form a loop with little loss of load capacity. In solar bracing applications, the LG-3 provides a very quick, easy method to tie and brace solar racks.

In addition to high load capacity, the LG-3 utilizes patent pending Dynamic Vibration Arrest (DVA) technology. Engaged by tightening the lock-screw, a secondary clamp is positioned to pinch each wire against the case (in addition to the primary wire grip(s)). This ensures the entire device vibrates in unison with the wire. Without DVA, in the case of wind or other vibration, a wire grip can shake loose, allowing the tie to fail. DVA prevents vibration failure. LG-3 grips provide the highest level of safety with the easiest installation and widest application portfolio of any gripping device.

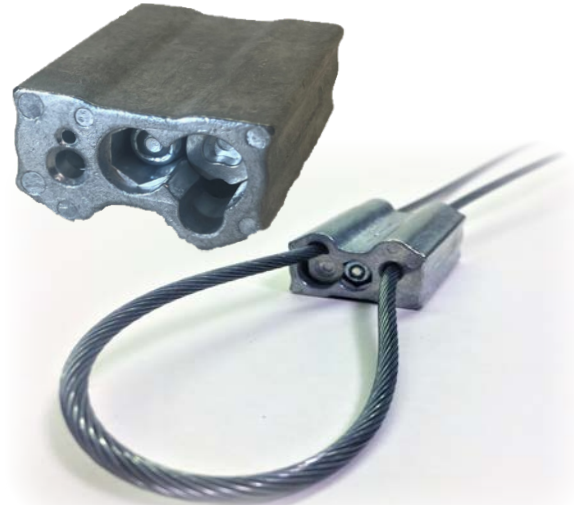

Falcon LockGrip LG-3 provides a two way grip of 1/8" (3mm) wire rope for a variety of bracing applications.

Benefits and Uses of the LockGrip Tensioner

- Squaring Tensile Brace
- Create Wire Rope Loop
- Couple Wire Ropes
- High-Load Capacity
- Vibration Resistance
- All Metal Construction
- Easily Adjustable
- Labor and Shipping Friendly

System Performance Loading Chart

	Maximum Working Load	Safe Working Load (Max Working Load/1.3 Safety Factor)
LG-3 with 1/8" Cable (Loop)	1,850 lbs*	1,425 lbs
* Maximum load verified by independent, accredited third party testing, when used in conjunction with cable supplied by Western Green.		



Falcon LockGrip LG-3 At a Glance

The Falcon LG-3 includes two, one-way cable grips that are positioned to operate in opposite directions. Additionally, a secondary grip is engaged by set screw, activating the DVA feature. Figures 1 & 2 show the LG-3 components.

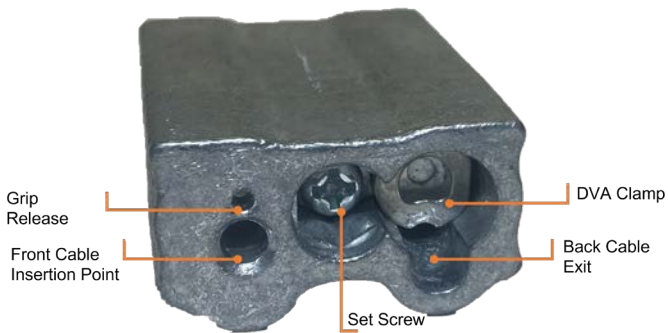

Fig. 1. LG-3 Front, Annotated

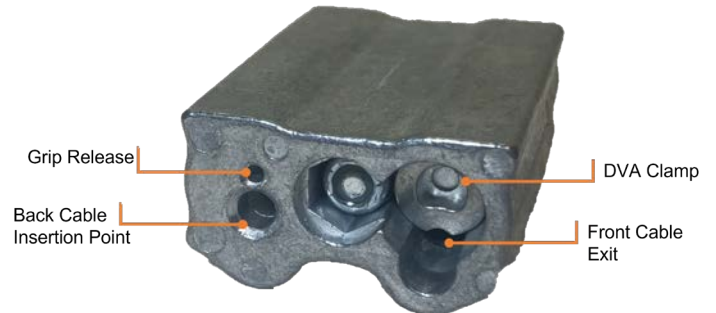
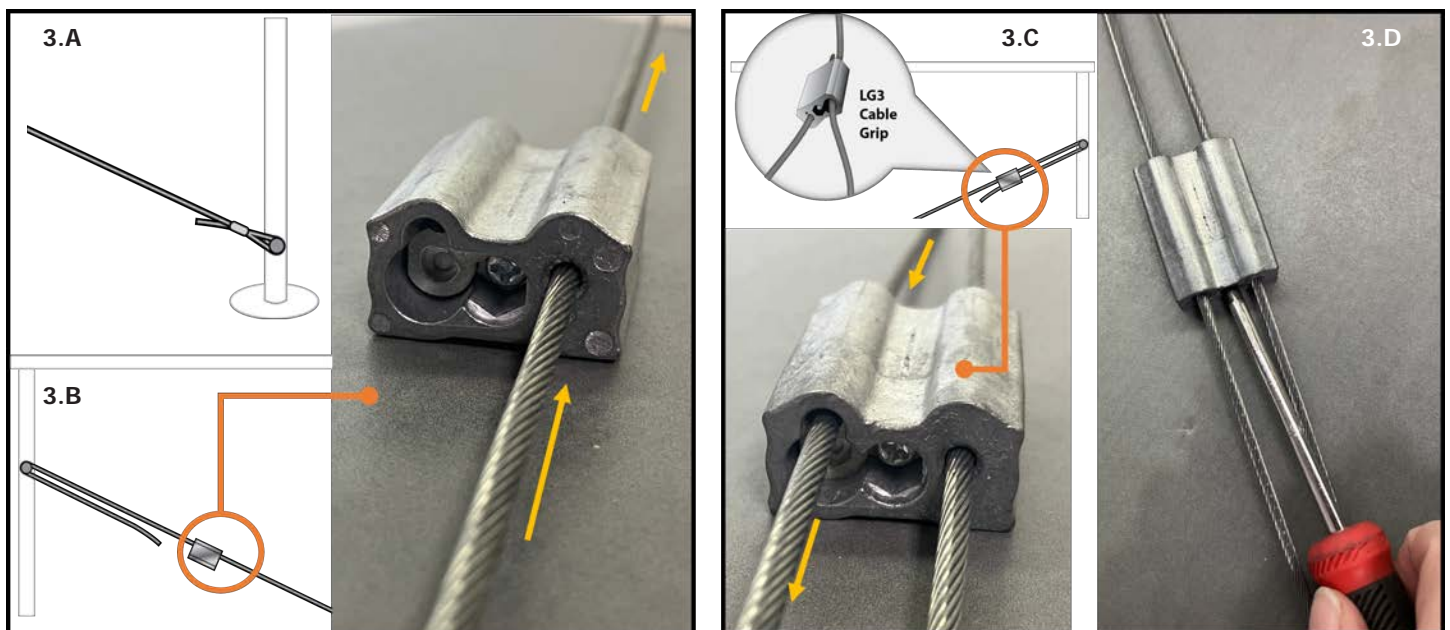

Fig. 2. LG-3 Back, Annotated

Cable Pass-Through and Setting the LockGrip LG-3 Tensioner

In typical applications, a cable (steel wire rope) is fixed to a frame or structure, then run to a separate point and looped through and back towards the origin (Fig. 3.A). In this configuration, the LG-3 is slid on to the cable prior to pass-through and the cable is passed back through the connector in the opposite direction (3.B).

In this configuration, it is best to slide the LG-3 onto the cable with the set screw facing the origin. Once the cable is passed through the destination point, and back through the LG-3, appropriate (application specific) tension is applied to the assembly by pulling on the loose end (3.C). Once the desired tension is applied, the set screw is engaged by twisting (clockwise, #1 Phillips) (3.D). See the full usage guide at www.falcon-anchors.com for additional details.



DISTRIBUTED BY:



Western Green
4609 E. Boonville-New Harmony Rd.
Evansville, IN 47725

westerngreen.com
800.772.2040

©2023. Falcon Anchors is a registered trademark. Certain products and /or applications described or illustrated herein are protected under one or more U.S. patents. Other U.S. patents are pending, and certain foreign patents and patent applications may also exist. Trademark rights also apply as indicated herein. Final determination of the suitability of any information or material for the use contemplated, and its manner or use, is the sole responsibility of the user. Printed in the U.S.A..



DISTRIBUTED BY:

ASP Enterprises, Quick Supply Co., Bowman Construction Supply & Cascade Geosynthetics are sister companies that serve customers from the Midwest, across the Rocky Mountains to the Pacific Northwest. Together we supply customers with a variety of environmental construction materials including erosion and sediment control, geosynthetics, stormwater management, drainage products, hardscapes and outdoor living, revegetation and soil amendments, waterproofing solutions and more.



We are full line distributors of environmental construction materials for all project types. Contact us for assistance with a project or a quote on products. From specification recommendations and project development to installation and completion, we're here to help with all of your site solution needs. Our warehouses are stocked with readily available inventory and we offer same and next-day deliveries.

ASP ENTERPRISES

aspent.com

salesasp@aspent.com

ST. LOUIS

1099 Cassens Industrial Ct.
St. Louis, MO 63026
636-343-4357

KANSAS CITY

5301 E 59th St.
Kansas City, MO 64130
816-554-1191

OMAHA

15263 Cooper St.
Omaha, NE 68138
402-861-8579

WICHITA

316-393-1554

WENTZVILLE

1906 E Service Rd. HWY 61 N
Wentzville, MO 63385
636-445-9090

QUICK SUPPLY CO.

quicksupplyco.com

salesquick@quicksupplyco.com

DES MOINES

6620 NW Toni Dr.
Des Moines, IA 50313
515-289-1271

BOWMAN CONSTRUCTION SUPPLY

bowmanconstructionsupply.com

salesbcs@bowmanconstructionsupply.com

DENVER

10801 E. 54th Ave.
Denver, CO 80239
303-696-8960

COLORADO SPRINGS

2445 Wayside Ct.
Colorado Springs, CO 80915
719-257-7840

LOVELAND

4495 Woods Ave.
Loveland, CO 80538
970-535-0863

CASCADE GEOSYNTHETICS

cascadageos.com

salescascade@cascadageos.com

PORTLAND

3610 N. Suttle Rd. Bldg B
Portland, OR 97217
971-339-1020

SALT LAKE CITY

425 N. Neil Armstrong Rd.
Salt Lake City, UT 84116
435-276-0820

**GEOSYNTHETICS | EROSION CONTROL | STORMWATER MANAGEMENT
REVEGETATION & SOIL AMENDMENTS | SEDIMENT CONTROL | HARDSCAPES**