

Allowable Moment (M)*	3,813 ft-lb/ft	16.96 kN-m/m
Section Modulus (Z)	14.3 in ³ /ft	769 cm ³ /m
Moment of Inertia (I)	57 in ⁴ /ft	7,784 cm ⁴ /m
Impact Strength**	456 in-lbs	51.52 N-m
Thickness (t)	0.285 in	7.2 mm
Section Depth	8.0 in	203 mm
Section Width	24 in	610 mm
Material	Weatherable Rigid Vinyl	
Cap Compatibility	AW-850, AW-850 STR, VersaCap® 8.5	
Standard Colors	Grey, Clay	
Technology	Box Profile, I-Beam Lock®, XCR™	
Standard Packaging	20 sheets/bundle	

* based on a 3200 psi allowable stress per ASTM D8427-21 and USACE EM 1110-2-2502

** based on a 1600 in-lbs/in impact strength normal to the sheet per ASTM D4226

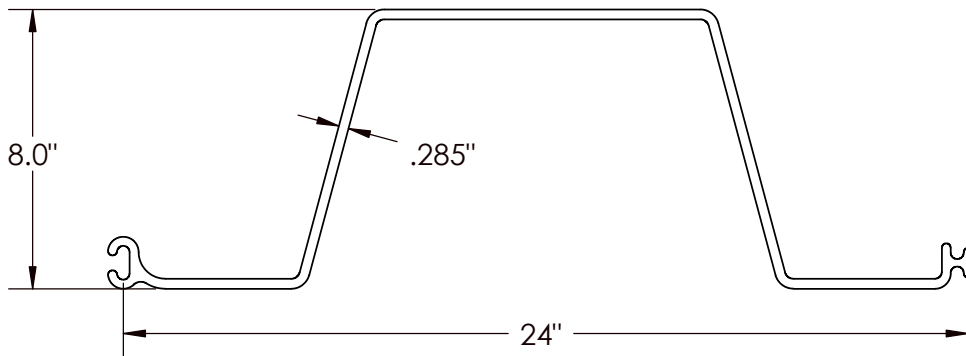



DISTRIBUTED BY:

ASP Enterprises, Quick Supply Co., Bowman Construction Supply & Cascade Geosynthetics are sister companies that serve customers from the Midwest, across the Rocky Mountains to the Pacific Northwest. Together we supply customers with a variety of environmental construction materials including erosion and sediment control, geosynthetics, stormwater management, drainage products, hardscapes and outdoor living, revegetation and soil amendments, waterproofing solutions and more.



We are full line distributors of environmental construction materials for all project types. Contact us for assistance with a project or a quote on products. From specification recommendations and project development to installation and completion, we're here to help with all of your site solution needs. Our warehouses are stocked with readily available inventory and we offer same and next-day deliveries.

ASP ENTERPRISES

aspent.com

salesasp@aspent.com

ST. LOUIS

1099 Cassens Industrial Ct.
St. Louis, MO 63026
636-343-4357

KANSAS CITY

5301 E 59th St.
Kansas City, MO 64130
816-554-1191

OMAHA

15263 Cooper St.
Omaha, NE 68138
402-861-8579

WICHITA

316-393-1554

WENTZVILLE

1906 E Service Rd. HWY 61 N
Wentzville, MO 63385
636-445-9090

QUICK SUPPLY CO.

quicksupplyco.com

salesquick@quicksupplyco.com

DES MOINES

6620 NW Toni Dr.
Des Moines, IA 50313
515-289-1271

BOWMAN CONSTRUCTION SUPPLY

bowmanconstructionsupply.com

salesbcs@bowmanconstructionsupply.com

DENVER

10801 E. 54th Ave.
Denver, CO 80239
303-696-8960

COLORADO SPRINGS

2445 Wayside Ct.
Colorado Springs, CO 80915
719-257-7840

LOVELAND

4495 Woods Ave.
Loveland, CO 80538
970-535-0863

CASCADE GEOSYNTHETICS

cascadageos.com

salescascade@cascadageos.com

PORTLAND

3610 N. Suttle Rd. Bldg B
Portland, OR 97217
971-339-1020

SALT LAKE CITY

425 N. Neil Armstrong Rd.
Salt Lake City, UT 84116
435-276-0820

**GEOSYNTHETICS | EROSION CONTROL | STORMWATER MANAGEMENT
REVEGETATION & SOIL AMENDMENTS | SEDIMENT CONTROL | HARDSCAPES**