



INSTALLATION GUIDELINE

# PROPEX Armormax for slopes



# Contents

<b>1. Introduction</b>	<b>3</b>
<b>2. Before installation</b>	<b>3</b>
<b>3. Installation: site preparation</b>	<b>3</b>
<b>4. PROPEX Armormax laydown</b>	<b>4</b>
<b>5. Installing anchors</b>	<b>7</b>
<b>6. Vegetation establishment</b>	<b>9</b>
<b>7. Project specific considerations</b>	<b>10</b>
<b>8. Short-term and long-term maintenance</b>	<b>10</b>

This information is provided for reference purposes only and is not intended as a warranty or guarantee. Solmax assumes no liability in connection with the use of this information. Please check the revision date and refer to our website for the latest updates.

# 1. INTRODUCTION

Thank you for purchasing **PROPEX** Armormax® for Erosion Control or Slope Stability by Solmax. This document provides installation and maintenance guidelines for **PROPEX** Armormax used as slope armoring to improve earthen slope resiliency and slope stability. The **PROPEX** Armormax system provides permanent erosion protection of an earthen slope, promotes vegetation, improves slope stability, and consists of two components:

- **PROPEX** PYRAMAT® 75 - High Performance Turf Reinforcement Mat (HPTRM)
- Engineered Earth Anchor (Anchor)

Temporary securing pins (pins) are used during installation to hold **PROPEX** Armormax in place while installing anchors. Pins also promote vegetation establishment keeping the system in intimate contact with the soil.

**PROPEX** Armormax is an Engineered Earth Armoring Solution™ with a unique design for each specific project. While Solmax has made every effort to ensure general validity, this information should not be used for a specific application without independent professional examination and verification of its suitability, applicability, and accuracy. The information provided herein is for general information only, and is intended to present installation guidance. Project specific contract documents take precedence when pin and anchor placements are different than what is represented in this document. Depending upon the critical nature of the structure to be armored, work restrictions may be in place such as limiting work based on growing seasons, weather patterns, etc. Work should be performed under the provisions set forth for the specific project. Solmax Engineering Services is available for support during installation to consult for solving constructability issues encountered in specific applications. Please feel free to contact our technical support team at [smatch@solmax.com](mailto:smatch@solmax.com).

## 2. BEFORE INSTALLATION

### 1. Coordinate with a Solmax representative:

A pre-construction meeting is suggested with the construction team and a representative from Solmax prior to installation. This meeting should be scheduled by the contractor with at least a two week notice.

**2. Gather the tools needed:** Tools that you will need to install **PROPEX** Armormax include a pair of industrial shears, tape measure, percussion hammer (sized appropriately for the anchors), ground rod driver compatible with the percussion hammer, drive steel compatible with the anchor, setting tool to set and load-lock the anchor, and wire/bolt cutters to cut the cable tendon of the anchor. If anchors will be load tested during construction, additional testing equipment may be necessary. Consult the “Anchor Load Test Manual” from Solmax for further guidance. Available for purchase from Solmax are drive steel, JackJaw® Setting Tools, wire cutters, and a gas powered anchor driver.

**3. Determine how to establish vegetation:** The method of vegetation establishment should be determined prior to the start of installation. Different vegetation establishment methods require different orders of installation. Refer to Vegetation Establishment for further guidance.

## 3. INSTALLATION: SITE PREPARATION

It is recommended during all stages of site preparation that disturbed soils remain unprotected for not more than a single day. Depending on project size this may require progressive site preparation during installation.

1. Grade and compact the area on the slope where **PROPEX** Armormax will be installed. The slope surface should be uniform and smooth, having all rocks, clods, vegetation or other objects removed so that during laydown, the HPTRM comes in direct, intimate contact with the slope surface.
2. Whether placing new fill or addressing a sloughed slope, appropriate placement and compaction is critical for the long term performance of the slope. In order to promote continuity of the slope and improve overall stability, any loose soil placed should be keyed into the existing slope and compacted in horizontal lifts per the engineer of record. To ensure compaction at the face of the slope, it is common practice to over-build the slope face, compact in lifts, and then regrade or trim the slope to the final grade.

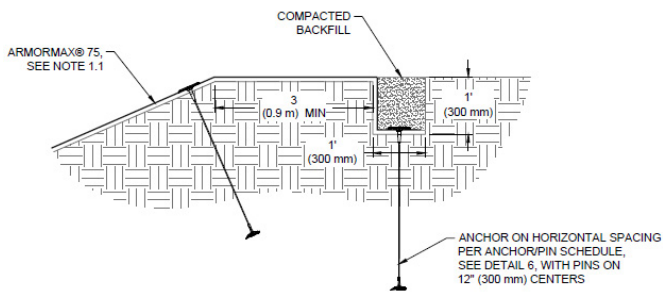

Figure 1A: Crest of Slope (COS) Trench

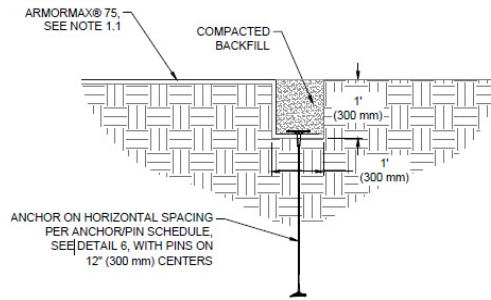

Figure 1B: Side/Perimeter Trench

3. Prepare the area to be armored with **PROPEX** Armormax by loosening the topsoil to promote better vegetation establishment. This may be accomplished with a rotary tiller on slopes 3:1 or flatter. For slopes greater than 3:1, prepare topsoil in a safe manner.
4. Excavate a Crest of Slope (COS) trench 12 in x 12 in (300 mm x 300 mm) minimum at a distance of 3 ft (900 mm) from the crest of the slope. (Figure 1a).
5. Excavate a Toe of Slope (TOS) trench 12 in x 12 in (300 mm x 300 mm) minimum at a minimum distance of 5 ft (1.5 m) from the toe of the slope. (Figure 2)

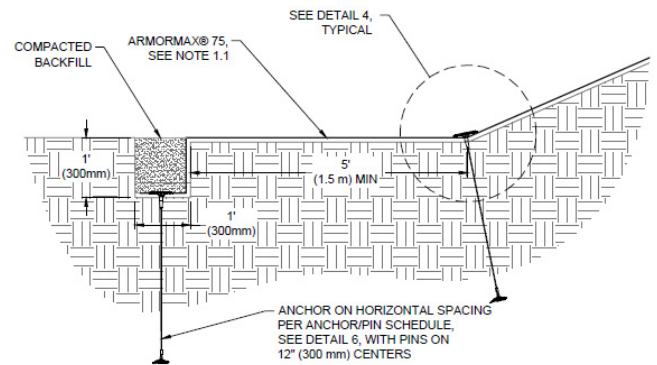

Figure 2: Toe of Slope (TOS) Trench

6. In some scenarios, a perimeter trench may be needed along the side of the installation. As needed, excavate the side/perimeter trench 12 in x 12 in (300 mm x 300 mm) minimum along the extents of the protected area.
7. If seeding, refer to vegetation establishment for additional considerations during site preparation.

## 4. PROPEX ARMORMAX LAYDOWN

1. Begin the **PROPEX** Armormax laydown process by starting with the downstream / downwind end of the site. To ensure proper anchoring of the overlapped areas the proceeding roll width must be laid out before the current roll width can be anchored with exception to the final roll width. For straight sections of a slope, the HPTRM panel lengths should be long enough to construct COS and TOS trenches while also covering the surface of the slope being armored (Figure 12). Panel edges should rest approximately perpendicular to the slope center line. For best results, panels of the HPTRM should be continuous and free from seams or roll end overlaps that are parallel to the centerline of the slope. Panel edge overlapping should follow a pattern of placing each proceeding panel's edge overtop the previous panel edge, shingling the panels in the direction of the water flow or prevailing wind.
2. Starting at the COS trench, lay **PROPEX** Armormax roll so that the roll ends point towards the crest of the slope (Figure 3), with a 3 in (75 mm) overlap created at adjacent panel edge locations. Ensure that adjacent panel edges maintain a minimum 3 in (75 mm) overlap during **PROPEX** Armormax laydown (Figure 8).

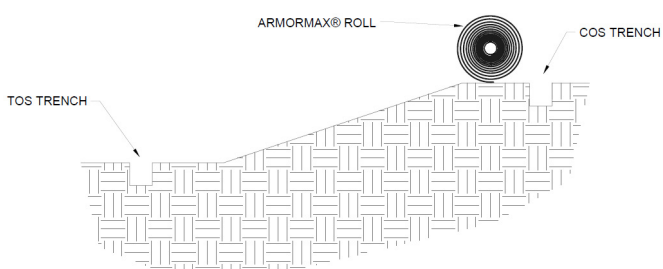

Figure 3: Crest of Slope (COS) Trench Alignment

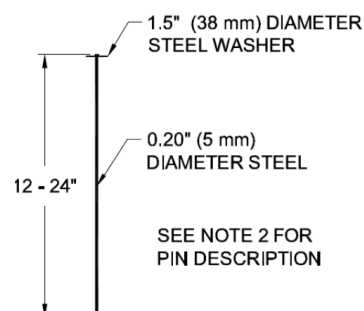

Figure 4: Securing Pin

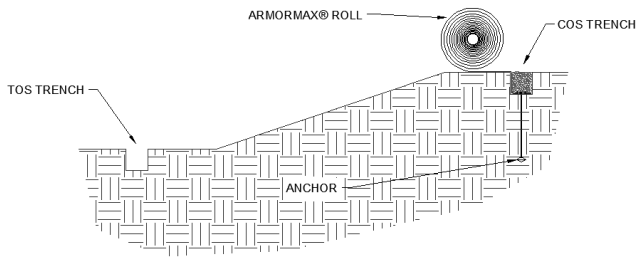

Figure 5: Crest of Slope (COS) Trench Placement

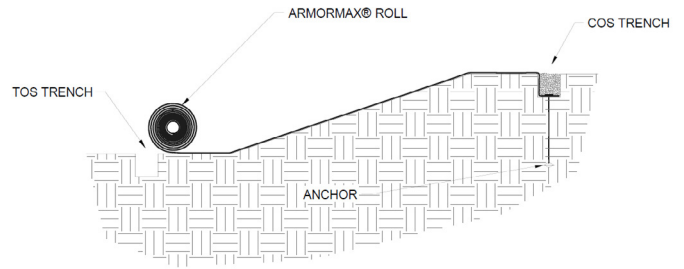

Figure 6: Placement of PROPEX Armormax across Slope

- Secure **PROPEX** Armormax with pins and secondary anchors in the COS trench. Pins should be made of steel with a 0.20 in (5 mm) minimum diameter, having a 1.5 in (38 mm) diameter washer at the head, and a length between 12 in and 24 in (300-600 mm) with sufficient ground penetration to resist pullout (Figure 4). Longer pins may be required for looser soils. Heaver metal stakes may be required in rocky soils. Suggested placement of pins and Secondary anchors for the COS trench is along the bottom of the trench with pins on 12 in (300 mm) centers in between Secondary anchors on 4 ft (1.2 m) centers. Secondary anchors should also be installed on panel edge overlaps in the COS trench.
- Backfill and compact the COS trench in the location of the first **PROPEX** Armormax panel only (Figure 5).
- Unroll the **PROPEX** Armormax roll on the slope surface in the area to be armored (Figure 6). Ensure that the HPTRM has intimate contact with the ground and all irregular surfaces beneath the material are removed.
- Secure HPTRM panels in place using pins, primary anchors, and anchors across the slope surface according to the project's engineered design. Pin and anchor placement should reflect a staggered checkerboard pattern across the slope surface for best results (Figure 7 and Figure 8).

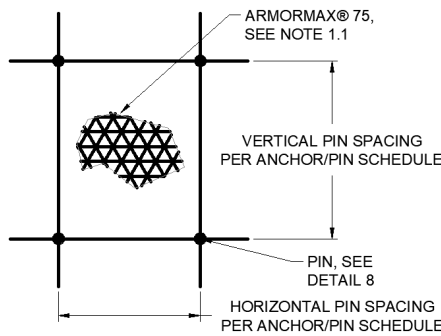

Figure 7: Example Pin Pattern

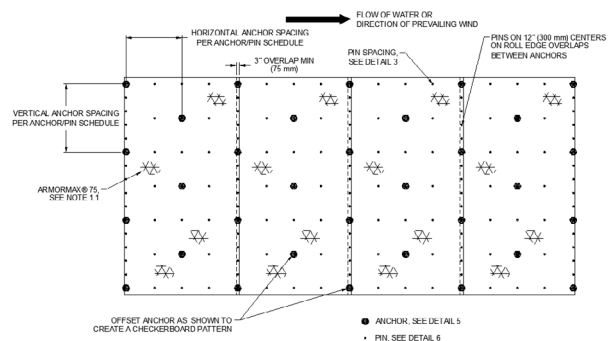

Figure 8: Example of Anchor Pattern - 0.5 Anchors/yd<sup>2</sup>

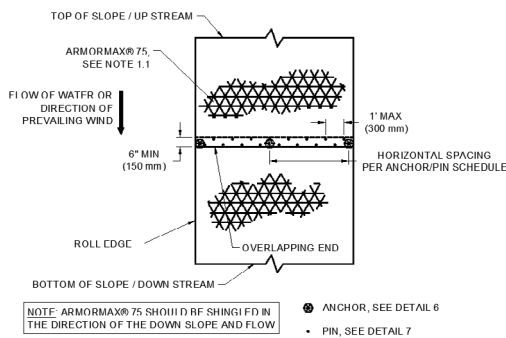

Figure 9: Roll End Overlap

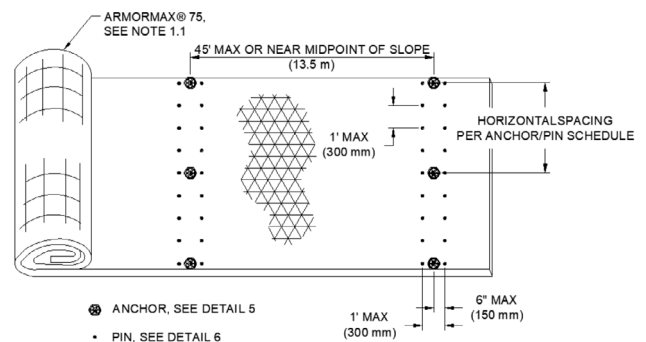
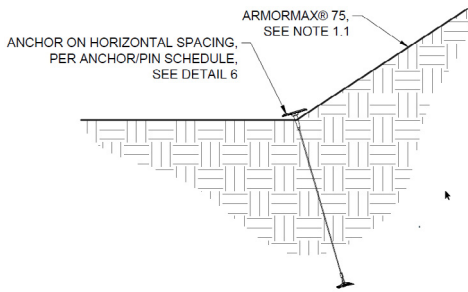
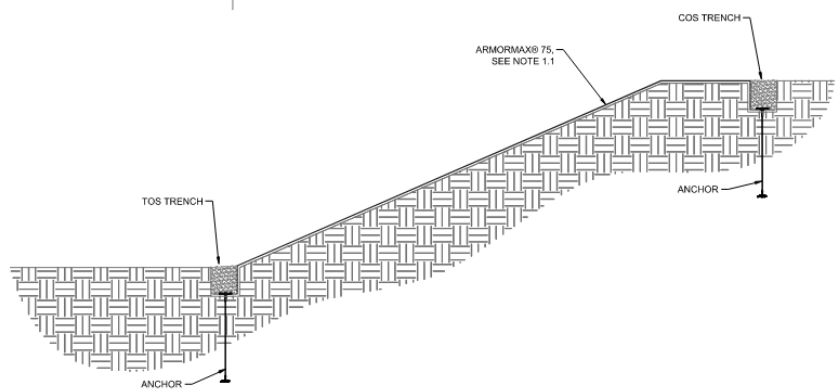

Figure 10: Simulated Check Slot

- The leading edge of the first **PROPEX** Armormax panel should be secured on the Slope Armoring Edge (SAE) with pins on 12 in (300 mm) centers in between anchors on intervals based on the slope stability analysis.
- Roll edges shall be overlapped a minimum of 3 in (75 mm) and a maximum of 6 in (150mm) with pins placed on 12 in (300 mm) centers in between anchors on intervals based on the slope stability analysis (Figure 8).
- Roll ends shall be overlapped a minimum of 6 in (150 mm) with upstream/upwind panel on top. Secure roll end overlaps with two rows of pins staggered 6 in (150 mm) apart on 12 in (300 mm) centers and with one row of anchors on intervals based on the slope stability analysis (Figure 9)
- For slope lengths greater than 45 ft (13.7 m), install simulated check slots. This method includes placing two rows of pins 12 in (300 mm) apart on 12 in (300 mm) centers and one row of anchors between the rows of pins on 4 ft (1.2 m) centers at 45 ft (13.7 m) maximum intervals or across the midpoint of the slope for slope lengths less than 60 ft (18.2 m) (Figure 10).
- At the break in slope interface towards the TOS, it is suggested that anchors be installed on intervals based on the slope stability analysis (Figure 11).



**Figure 11: Break in Slope Interface**



**Figure 12: Crest of Slope (COS) Trench and Toe of Slope (TOS) Trench Complete**

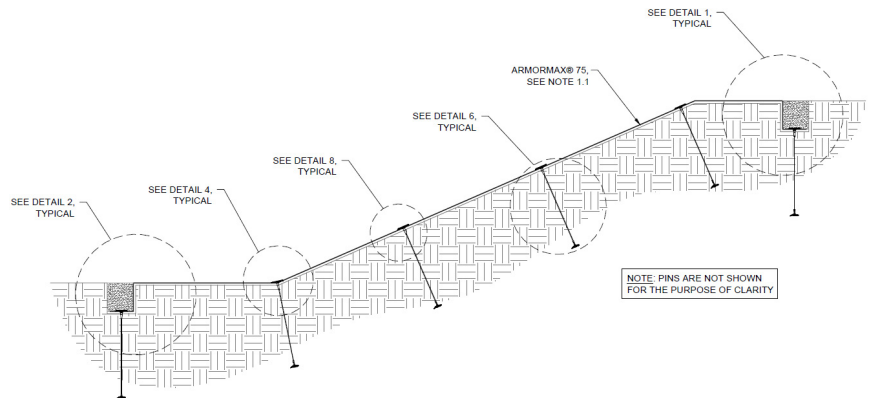

**Figure 13: Completed Slope Isometric View**

7. Secure **PROPEX** Armormax with pins and anchors in the TOS trench. Suggested placement of pins and anchors for the TOS trench is along the bottom of the trench with pins on 12 in (300 mm) centers in between anchors on 4 ft (1.2 m) centers (Figure 12).
8. Backfill and compact the TOS trench. (Figure 12)
9. Continue to work down the length of the slope by repeating steps 1 through 8 overlapping each adjacent HPTRM panel by 3 in (75 mm) (Figure 8). The last **PROPEX** Armormax panel should terminate on the Slope Armoring Edge (SAE) with pins on 12 in (300 mm) centers in between anchors on intervals based on the slope stability analysis. At a minimum, HPTRM panels should be pinned entirely across the slope surface, pins and anchors should be installed in the trenches, and the trenches should be backfilled and compacted at the end of each day to minimize rework in the case of a major rain event. Specific project conditions may warrant further evaluation of installation order for ease. An example elevation view (Figure 13) of a slope armored with **PROPEX** Armormax can be seen below for overall reference. Consult Solmax Engineering Services at (800) 621-1273 with any questions that you may have.

# 5. INSTALLING ANCHORS

The **PROPEX** Armormax anchor typically consists of an anchor head, a flexible cable tendon, and a load bearing plate. For quality control purposes and warranty claims, anchors should be delivered to the jobsite fully assembled and ready for installation.

Anchors are to be installed in locations specified for the project, and are typically installed in conjunction with **PROPEX** Armormax laydown. There are several options available from Solmax for different types of anchors. For optimal performance with the greatest risk reduction, it is important to select the proper anchor and perform the installation in accordance with the pattern designed for required resiliency and long term durability of the slope. Understanding the mechanics behind installing the anchor component of **PROPEX** Armormax will result in a quality **PROPEX** Armormax installation.

## 1. Engineered Earth Anchors

The installation of our Engineered Earth Anchors (Anchors) (Figure 14) is described below. The tools that you will need are a percussion hammer, a ground rod driver and drive steel compatible with the anchor and percussion hammer, a JackJaw setting tool, and wire cutters.

1. Use one piece drive steel or assemble segmental drive steel to the appropriate length in order to drive the anchor to the specified embedment depth.
2. Insert the tapered end of the drive steel into the hollow cavity of the anchor head. Position the anchor head/ drive steel tip above the ground at the drive location (Figure 15 and Figure 16).
3. Using a percussion hammer, guide the drive steel into the ground perpendicular to the slope surface at a smooth pace. Continue driving until the desired embedment depth is reached (Figure 17).

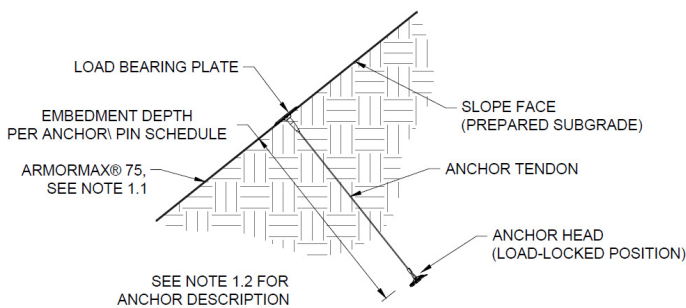

Figure 14: Anchor Detail



Figure 15: Insert Drive Steel into Anchor

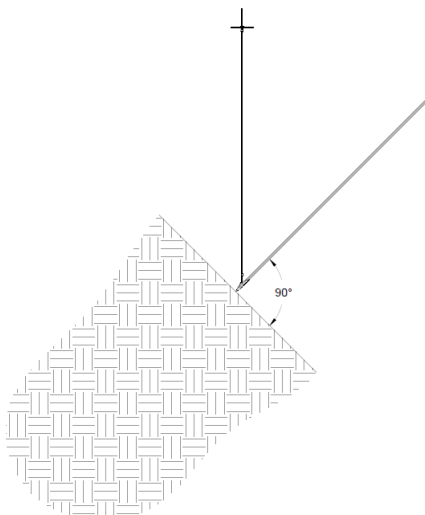

Figure 16: Position Anchor Head/Drive Steel Tip

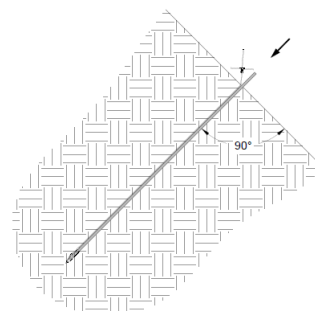
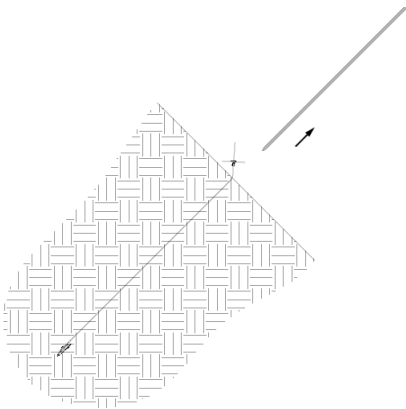
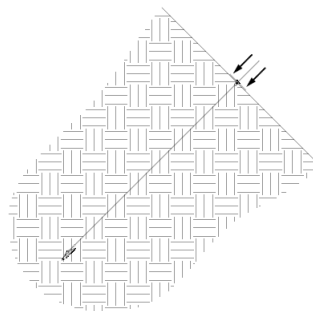

Figure 17: Drive Steel to Drive the Anchor into the Ground

4. Remove the drive steel from the ground. (Figure 18) Depending on soil conditions, this may require the use of a setting tool or leverage device.
5. Slide the load bearing plate down the anchor tendon towards the slope surface using your hands (Figure 19).
6. Once the plate is close to the slope surface, place the JackJaw Setting Tool on the anchor plate and place the top of the anchor tendon into the grips, keeping the anchor tendon perpendicular to the slope surface (Figure 20). With gentle force, slowly start to press down on the JackJaw lever – towards the slope surface - causing the anchor tendon to start to move out of the ground (displace). During this step, the anchor head will turn in the ground – a process known as “anchor setting”. The change in embedment depth of our Anchors can vary depending on the soil conditions and anchor type. When the anchor is set, there will be a noticeable change in the amount of force needed to displace the anchor any further. This is a good indication that the anchor head is now perpendicular to the anchor tendon and the anchor is ready to be load-locked.
7. To load-lock an anchor, continue to apply tension to the anchor tendon using the JackJaw Setting Tool creating a slight depression on the slope surface.
8. Once anchors have been load-locked, cut off the excess anchor tendon flush to the plate at the slope surface using wire cutters (Figure 21 and Figure 22).



**Figure 18: Remove Drive Steel from Ground**



**Figure 19: Slide Plate**

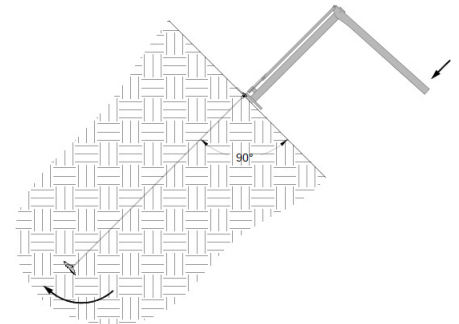

**Figure 20: Use JackJaw Setting Tool to Set Anchor**

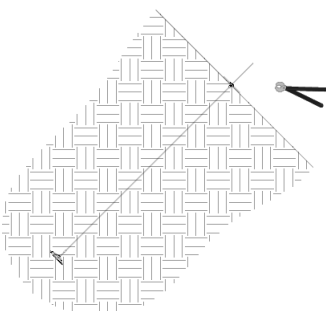

**Figure 21: Trim Extra Cable Flush to Plate**

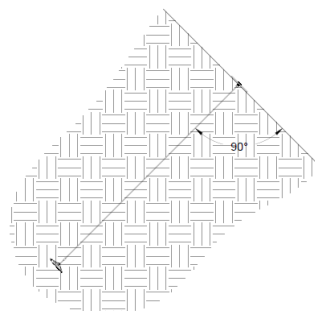

**Figure 22: Complete Anchor Installation**

## 6. VEGETATION ESTABLISHMENT

Vegetation can be established with **PROPEX** Armormax by broadcast seeding, hydraulic seed application (hydroseeding), or sodding. Seed application rate, seed type, sod type, and irrigation rate should be selected based on local or site specific knowledge and time of year. For best results, consider having a site specific soil test performed to help determine what soil amendments, such as lime and fertilizer, need to be incorporated into the soil to promote healthy vegetation.

### Broadcast seed

1. After conducting a site specific soil test, select and apply recommended soil amendments to the soil surface and then loosen/scarify the top 2 in to 3 in (50 to 75 mm) of the soil surface.
2. Sow 25%-35% of the total permanent seed mixture to prepared seedbed. Note this seed amount is in addition to the 100% total seed mixture being applied in Step 5.
3. Install the **PROPEX** Armormax.
4. Soil-fill the **PROPEX** Armormax with 1 in to 2 in (25-50 mm) of amended topsoil or fill with a biotic soil media. Do not place excessive soil above the **PROPEX** Armormax material.
5. Sow 100% of the permanent seed mixture and rake into place to ensure good contact between seed and soil.
6. Install surficial protection with **PROPEX** Landlok® S2 Erosion Control Blanket (ECB).

### SOD

1. After conducting a site specific soil test, select and apply recommended soil amendments to the soil surface and then loosen/scarify the top 2 in to 3 in (50 to 75 mm) of the soil surface prior to installation of the **PROPEX** Armormax
2. Install the **PROPEX** Armormax on the scarified surface.
3. Place sod on top of the **PROPEX** Armormax. Sod should be pinned/stapled into place to prevent displacement.
4. Optional: If there is less than 1 in (<25 mm) of topsoil included with the sod, it is recommended that a 1/2 in (12 mm) to 1 in (25 mm) of additional amended topsoil should be placed on top of the **PROPEX** Armormax prior to placement of the sod.

### Hydroseed

1. After conducting a site specific soil test, select and apply recommended soil amendments to the soil surface and the loosen/scarify the top 2 in to 3 in (50 to 75 mm) of the soil surface.
2. Sow 25%-35% of the total permanent seed mixture to prepared seedbed. Note this seed amount is in addition to the 100% total seed mixture being applied in Step 5.
3. Install the **PROPEX** Armormax.
4. Soil-fill the **PROPEX** Armormax with 1 in to 2 in (25-50 mm) of amended topsoil or fill with a biotic soil media. Do not place excessive soil above the **PROPEX** Armormax material.
5. Apply 100% of the total permanent seed mixture onto the topsoil/ biotic media with a hydroseed mixture that contains the soil amendments and a tackifier or with a bonded fiber matrix mixture per manufacturer's recommendations.
6. Optional Step for additional protection: Install surficial protection with **PROPEX** Landlok ECB.

Irrigate as necessary to establish and maintain vegetation until the desired vegetated density has been achieved. Frequent, light irrigation will need to be applied to seeded areas if natural rain events have not occurred within two weeks of seeding. When watering seeded areas, use a fine spray to prevent erosion of seeds or soil. Do not over irrigate. Proper irrigation guidance is provided under the Maintenance portion of this document.

## 7. PROJECT SPECIFIC CONSIDERATIONS

1. For applications that require special transitions (i.e. connections to riprap, concrete, T-walls, etc.), refer to the project specific drawings or consult with technical support at [smatch@solmax.com](mailto:smatch@solmax.com) or 706-693-2226
2. A deeper terminal trench and/or hard armoring may be required when slopes have severe scour potential at the toe location.
3. For installing **PROPEX** Armormax panels around curved sections of a slope, trim panels at an angle so that no more than two layers of HPTRM overlap at any point in time. Additional pins and anchors may be needed to secure panel edges towards the toe of the slope depending upon the radius of the curved slope. Install pins or anchors as necessary to securely fasten **PROPEX** Armormax to the ground.
4. Allowable Vehicle Traffic:
  - A. If using equipment on **PROPEX** Armormax, it should be of the rubber-tired type and should avoid sharp turns. Tracked equipment is not permitted to drive over the **PROPEX** Armormax without vegetation at any time.
  - B. Avoid any traffic over **PROPEX** Armormax if loose or wet soil conditions exist.
5. Disturbed areas should be reseeded. If ruts or depressions develop for any reason, rework soil until smooth and reseed such areas.

## 8. SHORT-TERM AND LONG-TERM MAINTENANCE

The purpose of this section is to provide some general guidelines for performing short-term and long-term maintenance of **PROPEX** Armormax with respect to maintaining vegetation reinforced with **PROPEX** Armormax and patching of **PROPEX** Armormax (in the event it needs to be removed or replaced). These procedures are to be considered minimum guidelines for proper maintenance, and further maintenance techniques may be appropriate considering local practices and procedures.

### 1. PROPEX Armormax protected slopes

For **PROPEX** Armormax to be most effective, it is important to ensure that it is properly maintained both during construction and after construction. Identifying trouble areas is easy, and it can make identifying potential threats much simpler and manageable. Look for areas with sparse, dying, or no vegetation as these are obvious signs that the HPTRM is losing intimate contact with the slope surface. If loss of ground surface occurs, **PROPEX** Armormax will need to be removed and reinstalled as described in Patching and Repairs section after the eroded area is backfilled with compacted soil that is similar to material of the slope. After **PROPEX** Armormax is reinstalled, re-establish vegetation on the newly installed **PROPEX** Armormax and disturbed areas. Monitor the sites to determine if frequent watering may be required to establish vegetation.

To minimize exposure to unwanted maintenance and repair, **PROPEX** Armormax armored slopes should be free of unauthorized vehicular traffic. Routine maintenance and slope inspections should be performed with rubber tired vehicles. Tracked equipment such as skid steers, excavators, or dozers should only be allowed to traffic over **PROPEX** Armormax in times of emergency after vegetation establishment is complete. Failure to control unauthorized traffic can result in **PROPEX** Armormax being damaged resulting in erosion below **PROPEX** Armormax during storm events. In addition, routine mowing maintenance should be used to keep the protected area free of unwanted brush, saplings, and trees. Selective herbicides that target only the unwanted plants can be used as long as the vegetation established with **PROPEX** Armormax is not impaired. Failure to control the sapling and tree growth can result in the trees being uprooted during a flood.

## 2. Maintaining vegetation

good vegetative cover will ensure maximum performance of **PROPEX** Armormax. Vegetative cover care starts before a project is complete and is ongoing until all **PROPEX** Armormax is installed. Vegetative cover should be given every opportunity to grow and establish well. This will require that a contractor periodically fertilize, water, and mow the grasses as needed until a project is complete in the short-term, with the owner of the slope fulfilling the maintenance of the slope in a similar fashion for the long-term. For the entire lifecycle of **PROPEX** Armormax, every effort must be made to prevent unauthorized encroachments, grazing, vehicle traffic, the misuse of chemicals, or burning during inappropriate seasons.

1. After the installation of vegetation is complete, immediately water and soak the entire area using a fine spray to prevent erosion and loss of seeds. A suggested amount of water is identified below. Prior to installation if using sod, the sod pads in storage should be kept moist at all times and not stored for more than 24 hours from site arrival to installation. Warmer weather will necessitate more frequent applications than listed below.
  - A. For each reach/segment of installed vegetation, watering shall be conducted immediately after each installation or the day's work.
  - B. For initial vegetation establishment, water vegetation in a manner consistent with best practices for vegetation type and location.
  - C. Establish a watering schedule and follow until vegetation is well established and will thrive in the absence of manual watering.
  - D. Avoid excessive application of water, so that surface runoff does not occur. Runoff should be prohibited. However, additional watering may be required for repaired or damaged areas.
2. Fertilizer should be applied as needed to address any nutrient deficiencies revealed in soil testing.
3. Implement best practices for mowing over **PROPEX** Armormax. While **PROPEX** Armormax is designed to withstand non-hydraulic stresses such as mowing, there are procedures to minimize exposure to unwanted damage.
  - A. Immediately after installation, signage and post shall be installed stating that "Vehicles and Pedestrians are Prohibited from Access" on the slopes and the newly installed vegetation. Signage shall be posted every 1,500 lineal feet.
  - B. Vegetated areas should be mowed to a height no less than 6 in (152 mm) and no greater than 12 in (305 mm) from natural ground after a period of 60 days of growth. The excessive grass clippings created from mowing shall be evenly spread on the slope section outside of the armored area. Periodic and final grass mowing should be performed until final inspection and acceptance of slope work. Monitor the vegetated areas throughout winter months and generate reports as needed, noting any issues that should be addressed. Minimum mowing heights will depend on the vegetation density and should be as follows:
    - i. 6" with 0 – 30% vegetation establishment
    - ii. 4" with 30 – 70% vegetation establishment
    - iii. 3" with 70 – 100% vegetation establishment
  - C. To prevent damage to the newly established vegetation, the mowing tractor should be fitted with 3-rib agriculture tires. Note that tractors with 8 ft (2.4 m) flail mowers provide best results. Tractors with 15 ft (4.6 mm) brush hogs should avoid sharp turns up the slope to prevent damage to vegetation.
  - D. Mowing should not take place for a minimum of 48 hours after a rainfall event of 2 in (55 mm) or more to minimize the potential for rutting and/or damage to the slope surface. Maintenance mowing of the slope should be done on a consistent basis to prevent vegetation growing to more than 3 ft (0.9 m) in height. This will minimize thatch thickness and potential damage to **PROPEX** Armormax. If turn-around pads are present, operate mowing equipment utilizing the turn-around pads to the fullest extent. The mowing blade height over **PROPEX** Armormax should be a minimum of 8 in (203 mm). However, should vegetation grow to more than 3 ft (0.9 m) in height, the mowing blade height for the condition should be a minimum of 12 in (305 mm).

4. Some special circumstances may exist. When mowing the crown of a slope with a crown or crest equal to or exceeding 20%, it should be mowed with an articulating arm mower to minimize the potential for the mower blades to catch **PROPEX** Armormax at the slope surface. The articulating arm mower should be level on the surface with the articulating arm extending over the crown. Pay close attention to areas where the slope changes. The mower blades should be set at a minimum height of 8 in (203 mm). If **PROPEX** Armormax is damaged by the mowing blades at any time, mowing should stop immediately and further direction should be obtained to continue activity. Repair the damaged area as described in the Patching and Repairs section below.
5. **PROPEX** Armormax protected slopes are not as susceptible to animal burrowing due the tenacity of the **PROPEX** Armormax; however, inspections to detect the presence of burrowing animal activity are generally most effective immediately after the slope has been mowed. Animal burrows that are identified should be thoroughly excavated and inspected, backfilled with compacted soil that is similar to material of the slope, and vegetation re-established. This will avoid the possibility of water piping through unfilled portions of the burrows. Should **PROPEX** Armormax be damaged, it is to be repaired as described Patching and Repairs section below.

### 3. Patching and repairs

**PROPEX** Armormax may require localized repair at times. For emergency repairs, an adequate supply of **PROPEX** Armormax should be maintained in inventory with the necessary tools to install. This will allow for a timely, initial repair of the system.

1. In order to identify areas in need of repair, the site should be patrolled immediately after mowing and after rain events of 2 in (51 mm) or more. When patrolling look for areas of sparse vegetation, exposed edges of **PROPEX** Armormax, and areas where direct contact between **PROPEX** Armormax and the slope surface is compromised. **PROPEX** Armormax should be rated as Acceptable, Minimally Acceptable, or Unacceptable during inspection.
  - A. Acceptable (A) - The rated area is in satisfactory, acceptable condition, and will function as designed and intended during the rain event. **PROPEX** Armormax has no exposed edges, is installed tightly by maintaining direct contact to the slope surface with no rilling beneath, and has over 90% vegetation cover. There is no noticeable damage present.
  - B. Minimally Acceptable (M) - The rated area has a minor deficiency that needs to be corrected. The minor deficiency will not seriously impair the functioning of the area during the next rain event; however, the overall reliability of the project will be lowered because of the minor deficiency. **PROPEX** Armormax has 75% vegetation cover with un-vegetated patches as large as one square yard. Edges of **PROPEX** Armormax are exposed with noticeable damage. Minimal erosion has occurred underneath **PROPEX** Armormax.
  - C. Unacceptable (U) - The rated area is unsatisfactory. The deficiency is so serious that the area will not adequately function in the next rain event. **PROPEX** Armormax has been physically torn, ripped, or lifted from the slope surface. Less than 75% vegetation cover is present with un-vegetated patches being greater than 1 y<sup>2</sup> (0.9 m<sup>2</sup>), and there is evidence that erosion is occurring beneath **PROPEX** Armormax.
2. Repair any raised or exposed edges of **PROPEX** Armormax by driving existing and additional pins or anchors along the edges as necessary to securely fasten to the ground. Inspect areas where the vegetation is not growing on top of **PROPEX** Armormax. Many times this is an indicator that **PROPEX** Armormax has lost contact with the ground beneath. Check for voids beneath **PROPEX** Armormax and fill any holes, gullies, etc. with compacted fill material if possible. Replace **PROPEX** Armormax as described below.

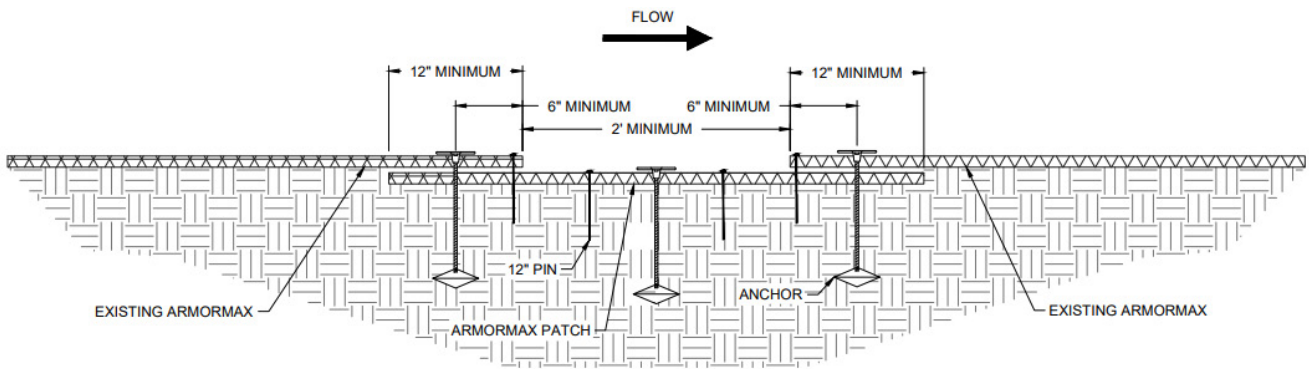

Figure 23: PROPEX Armormax Patch Cross Section

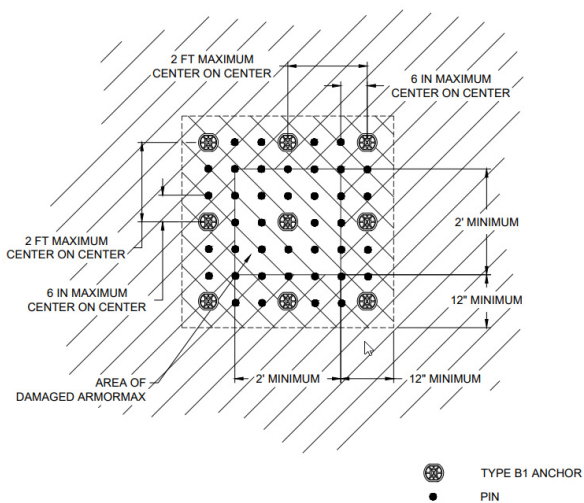

Figure 24: PROPEX Armormax Patch Plan View

3. To repair **PROPEX** Armormax, cut out and remove damaged areas in a square configuration a minimum size of 2 ft by 2 ft (0.6 m x 0.6 m). Remove all vegetation and debris atop of **PROPEX** Armormax. Loosen the top 1 in to 2 in (25 mm - 50mm) of soil in the patch area then seed. The subgrade of area to be patched shall be prepared to be smooth and uniform and transition smoothly into the in-situ area. Cut a square **PROPEX** Armormax patch a minimum of 12 in (305 mm) greater than the damaged area for all four sides of the patch. Overlap the patch area in all directions a minimum of 12 in (305 mm). The patch overlaps shall be tucked under the existing damaged **PROPEX** Armormax material (Figure 23 and Figure 24).
4. Install anchors on 2 ft (600 mm) (max) centers, and pins on 6 in (150 mm) (max) centers. For larger areas of damage, anchors should be installed to match existing anchor pattern and type. Once **PROPEX** Armormax is in place, vegetate per project specifications.

#### 4. Summary

Maintenance should consist of watering and weeding, repair of all erosion, and any re-seeding as necessary to establish a uniform stand of vegetation during construction and beyond. A minimum of 70% of the armored area should be covered with no bare or dead spots greater than 10 ft<sup>2</sup> (1 m<sup>2</sup>). Establishing vegetation should not be mowed prior to 70% vegetative density and a minimum grass growth of 4 in (100 mm). Throughout the duration of the project, the contractor should be responsible for mowing to facilitate growth and should not let the vegetation in the armored areas exceed 18 in (450 mm). In addition, the Contractor should water all grassed areas as often as necessary to establish satisfactory growth and to maintain its growth throughout the duration of the project. After the project is complete, it is the responsibility of the Owner to maintain and upkeep all **PROPEX** Armormax installed areas for long term performance and best results as described herein for superior slope armoring.

### **About Solmax**

Solmax is a world leader in sustainable construction solutions, for civil and environmental infrastructure. Its pioneering products separate, contain, filter, drain and reinforce essential applications in a more sustainable way – making the world a better place.

The company was founded in 1981, and has grown through the acquisition of GSE, TenCate Geosynthetics and PROPEX. It is now the largest geosynthetics company in the world, empowered by more than 2,000 talented people. Solmax is headquartered in the province of Quebec, Canada, with subsidiaries and operations across the globe.

### **Uncompromised quality**

Our products are manufactured to strict international quality standards. All our products are tested and verified at our dedicated and comprehensive laboratories which maintain numerous accreditations. We offer our partners a wide scope of testing according to published standards to ensure products delivered to sites meet specified quality requirements.

# Let's build infrastructure better



Solmax is not a design or engineering professional and has not performed any such design services to determine if Solmax's goods comply with any project plans or specifications, or with the application or use of Solmax's goods to any particular system, project, purpose, installation, or specification.

Products mentioned are registered trademarks of Solmax in many countries of the world.

**SOLMAX.COM**



## DISTRIBUTED BY:

ASP Enterprises, Quick Supply Co., Bowman Construction Supply & Cascade Geosynthetics are sister companies that serve customers from the Midwest, across the Rocky Mountains to the Pacific Northwest. Together we supply customers with a variety of environmental construction materials including erosion and sediment control, geosynthetics, stormwater management, drainage products, hardscapes and outdoor living, revegetation and soil amendments, waterproofing solutions and more.



We are full line distributors of environmental construction materials for all project types. Contact us for assistance with a project or a quote on products. From specification recommendations and project development to installation and completion, we're here to help with all of your site solution needs. Our warehouses are stocked with readily available inventory and we offer same and next-day deliveries.

### ASP ENTERPRISES

[aspent.com](http://aspent.com)

[salesasp@aspent.com](mailto:salesasp@aspent.com)

#### ST. LOUIS

1099 Cassens Industrial Ct.  
St. Louis, MO 63026  
636-343-4357

#### KANSAS CITY

5301 E 59th St.  
Kansas City, MO 64130  
816-554-1191

#### OMAHA

15263 Cooper St.  
Omaha, NE 68138  
402-861-8579

#### WICHITA

316-393-1554

#### WENTZVILLE

1906 E Service Rd. HWY 61 N  
Wentzville, MO 63385  
636-445-9090

### QUICK SUPPLY CO.

[quicksupplyco.com](http://quicksupplyco.com)

[salesquick@quicksupplyco.com](mailto:salesquick@quicksupplyco.com)

#### DES MOINES

6620 NW Toni Dr.  
Des Moines, IA 50313  
515-289-1271

### BOWMAN CONSTRUCTION SUPPLY

[bowmanconstructionsupply.com](http://bowmanconstructionsupply.com)

[salesbcs@bowmanconstructionsupply.com](mailto:salesbcs@bowmanconstructionsupply.com)

#### DENVER

10801 E. 54th Ave.  
Denver, CO 80239  
303-696-8960

#### COLORADO SPRINGS

2445 Wayside Ct.  
Colorado Springs, CO 80915  
719-257-7840

#### LOVELAND

4495 Woods Ave.  
Loveland, CO 80538  
970-535-0863

### CASCADE GEOSYNTHETICS

[cascadageos.com](http://cascadageos.com)

[salescascade@cascadageos.com](mailto:salescascade@cascadageos.com)

#### PORTLAND

3610 N. Suttle Rd. Bldg B  
Portland, OR 97217  
971-339-1020

#### SALT LAKE CITY

425 N. Neil Armstrong Rd.  
Salt Lake City, UT 84116  
435-276-0820

**GEOSYNTHETICS | EROSION CONTROL | STORMWATER MANAGEMENT  
REVEGETATION & SOIL AMENDMENTS | SEDIMENT CONTROL | HARDSCAPES**